

# Panasonic

## Quick Reference Guide

IP Proprietary Telephone

Model No. **KX-NT321**





Thank you for purchasing an IP Proprietary Telephone (IP-PT). Please read this manual carefully before using this product and save this manual for future use.

For more details, please refer to the manuals of the PBX.

**Note:** In this manual, the suffix of each model number is omitted unless necessary.

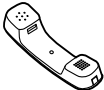
### Accessories (included)

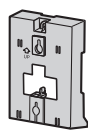
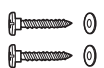
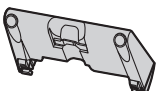
<input type="checkbox"/> Handset  One	<input type="checkbox"/> Handset Cord  One	<input type="checkbox"/> Wall Mounting Adaptor  One
<input type="checkbox"/> Screws  Two	<input type="checkbox"/> Stand  One	

### This model supports the following PBX versions and CODEC types:

KX-TDA15/KX-TDA30: PSMPR Software File Version 4.0000 or later

KX-TDA100/KX-TDA200: PMPR Software File Version 5.0000 or later

KX-TDA600: PLMPR Software File Version 5.0000 or later

KX-TDE100/KX-TDE200: PMMPR Software File Version 1.0000 or later

CODEC: G.729A, G.711, G.722 \*<sup>1</sup>

\*<sup>1</sup> G.722 is only available for KX-TDE100/KX-TDE200.

# Location of Controls

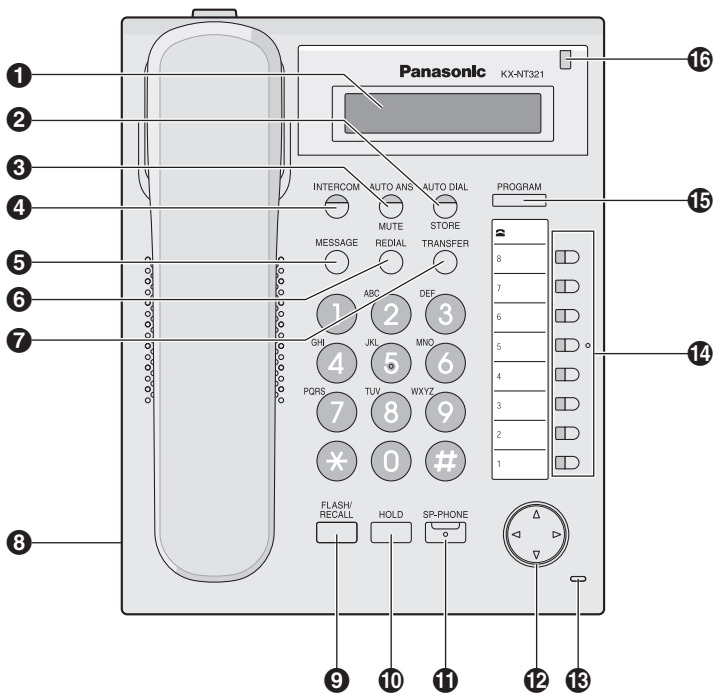

- 1 LCD (Liquid Crystal Display)**
- 2 AUTO DIAL/STORE:** Used for System/Personal Speed Dialling or storing programme changes.
- 3 AUTO ANS (Auto Answer)/MUTE:** Used to receive an incoming call in hands-free mode or mute the microphone/handset during a conversation.
- 4 INTERCOM:** Used to make or receive intercom calls.
- 5 MESSAGE:** Used to leave a message waiting indication or call back the party who left the message waiting indication.
- 6 REDIAL:** Used to redial the last dialled number.
- 7 TRANSFER:** Used to transfer a call to another party.
- 8 Headset Jack**
- 9 FLASH/RECALL:** Used to disconnect the current call and make another call without hanging up.
- 10 HOLD:** Used to place a call on hold.
- 11 SP-PHONE (Speakerphone):** Used for performing hands-free operations.
- 12 Navigator Key:** Used to adjust the volume and the display contrast or select desired items.
- 13 Microphone:** Used for hands-free conversations.
- 14 Flexible CO Buttons:** Used to seize an outside line or perform a feature that has been assigned to the key.
- 15 PROGRAM:** Used to enter and exit the personal programming mode.
- 16 Message/Ringer Lamp:** When you receive an intercom call, the lamp flashes green, and on an outside call, the lamp flashes red. When someone has left you a message, the lamp stays on red.

# Settings

<b>Speaker volume</b>	<i>While in a hands-free conversation</i>	
<b>Handset/Headset volume</b> <sup>*1</sup>	<i>While using the handset or headset</i>	
<b>Ringer volume</b>	<i>While on-hook or receiving a call</i>	

Press **Up** to increase or **Down** to decrease the volume.

## LCD Contrast

*While on-hook*





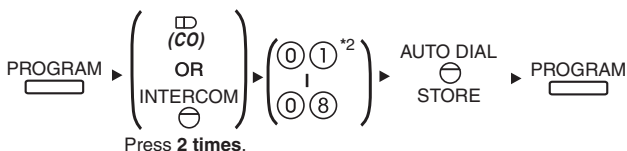

## Ring Tone



















<sup>\*1</sup> If you hear your own voice through the handset or headset, decrease the volume.

<sup>\*2</sup> The ring tone pattern of patterns 09 to 30 is the same as pattern 01.

## Icon Meanings

 = Flexible CO button   
  = Off-hook   
  = On-hook  
 = Feature number   
  = Talk   
 C.  Tone = Confirmation Tone

## Making Calls

Calling	
<b>To an extension</b>  ► <input data-bbox="139 414 315 444" type="text" value="extension no."/> ► 	<b>To an outside party</b>  ►  (CO) ► <input data-bbox="626 414 833 444" type="text" value="outside phone no."/> ► 
Redial	
 ► REDIAL ►  ► 	
Quick Dialling	
 ► <input data-bbox="139 662 315 691" type="text" value="quick dial no."/> ► 	
One-touch Dialling	
<b>To store</b> PROGRAM <input data-bbox="88 837 160 866" type="text"/> ►  (CO) ►  ② ► <input data-bbox="398 808 574 866" type="text" value="desired no.* (max. 32 digits)"/> ► AUTO DIAL  ► PROGRAM <input data-bbox="802 837 875 866" type="text"/> STORE * Enter outside line access number before outside phone number.	
<b>To dial</b>  ►  (One-touch Dialling) assigned as a One-touch Dialling button ► 	

# Features List

## Personal Speed Dialling

### To store



\* Enter outside line access number before outside phone number.

### To dial



## System Speed Dialling

### To dial

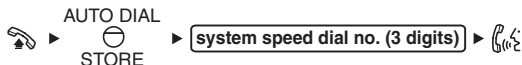

## Doorphone Call

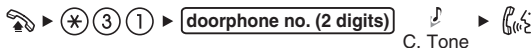

## During a Conversation

### Call Hold

#### To hold



#### To retrieve a call at the holding extension



#### To retrieve an outside call from another extension



## Call Transfer

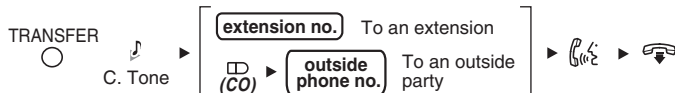

## Useful Features

### Multiple Party Conversation

#### To add other parties during a conversation (i.e., conference)

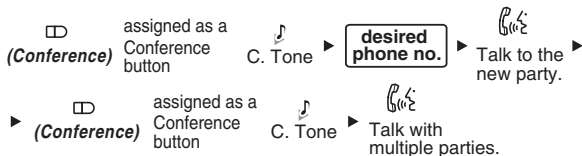

#### To leave a conference

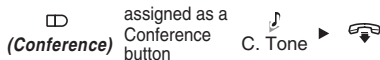

## Setting the Telephone According to Your Needs

### Do Not Disturb

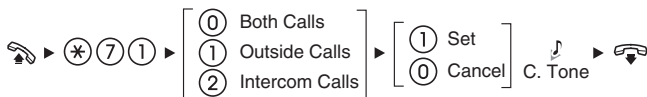

### Timed Reminder

#### To set

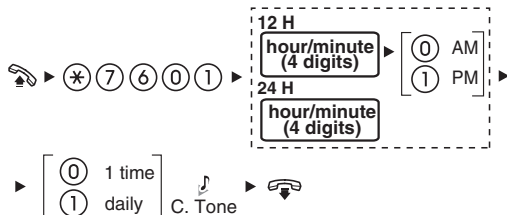

#### To cancel



#### To stop or answer the ring back



# Features List

## Before Leaving Your Desk

### Call Forwarding

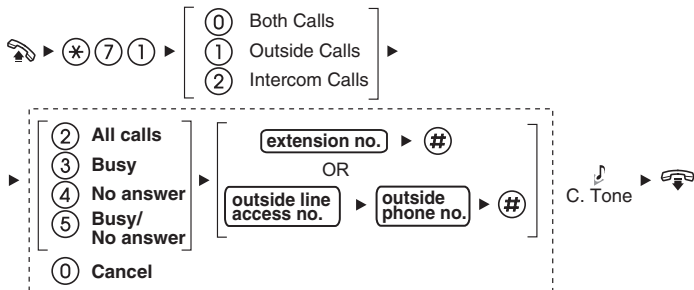

## Making Use of the Voice Mail Service

### Listening to a message

#### From your own extension

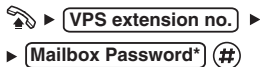

\* If you have no password, you can skip the last step.

#### From someone else's extension

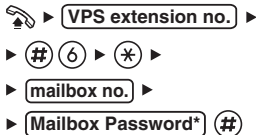

\* If you have no password, you can skip the last step.

#### KX-TVM series

- 1 Listen to Message
- 2 Deliver Message
- 3 Mailbox Management
- ▶ 4 Automated Attendant
- 5 Message Notification
- 6 Other Features
- \* End Call

#### KX-TVP series

- 1 Listen to Message
- 2 Deliver Message
- 3 Check Mailbox Distribution
- ▶ 4 Automated Attendant
- 5 Mailbox Management
- 6 Other Features
- \* End Call

## Leaving a message

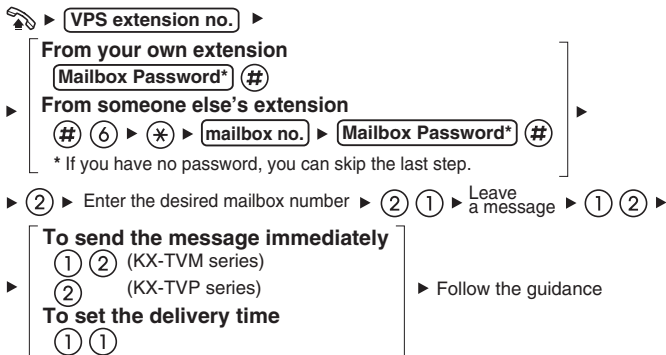

## During playback

- 0** Repeat Voice Guidance
- \*** Exit

- Consult your dealer or the network administrator for more details regarding feature numbers.
- It is possible to assign flexible CO buttons as feature buttons.
- Control panel/button names and descriptions can be found in "Location of Controls" on page 2.

## Connection

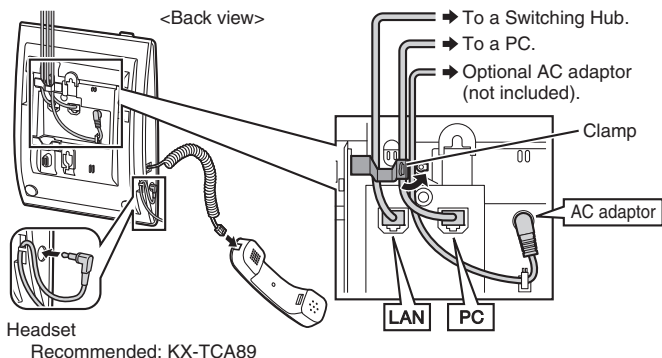

### PC connection/Switching Hub connection

- Use a straight CAT 5 (or higher) Ethernet cable (not included) that is 6.5 mm in diameter or less.
- For further information on the connection to a PC, refer to the documentation provided for the PBX.

### AC adaptor

- Use a Panasonic AC adaptor KX-A239UK (PQLV206E).
- The AC adaptor is used as the main disconnect device. Ensure that the AC outlet is located near the unit and is easily accessible.

### CAUTION:

#### When selecting Ethernet cables

- Use flexible, high-quality, snagless (without strain relief) cables. Do not use cables with coating that may tear or crack when bent.

#### When connecting cables

- Ensure that the Ethernet cables and the AC adaptor cord are clamped to prevent damage to the connectors.
- Cables may be routed upwards by using the appropriate cable clamp located on the back of the unit.

#### When connecting a headset and AC adaptor

- Ensure that the headset cord and the AC adaptor cord are wound around the hook to prevent damage to the connectors.

### Attaching the Stand

Place the catches (A) of the stand into hooks located in the unit. Gently push the stand in the direction indicated until it locks into place. The stand will be mounted in the high position.

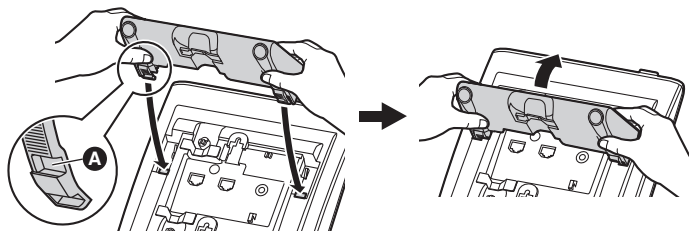

### Removing the Stand

Hold the stand with both hands.

Gently rotate the stand in the direction indicated until it is released.

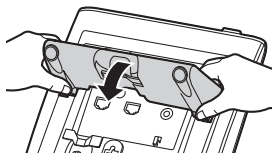

### Cabling

When using the stand, ensure that the cables are clamped as shown.

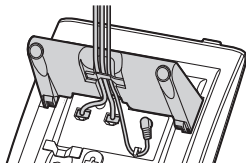

## Stand Usage

---

### Adjusting from High to Low Position

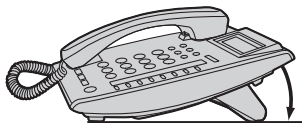

Hold the stand with both hands as shown and rotate the stand in the direction indicated until it locks into the low position (B).

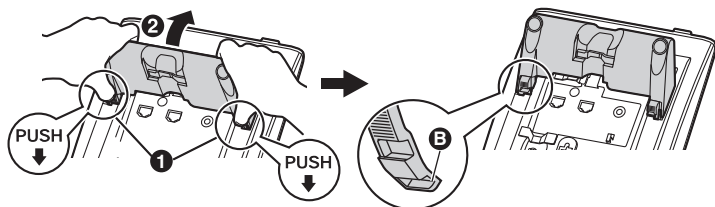

### Adjusting from Low to High Position

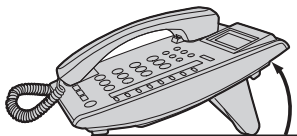

Hold the stand with both hands as shown and rotate the stand in the direction indicated until it locks into the high position (A).

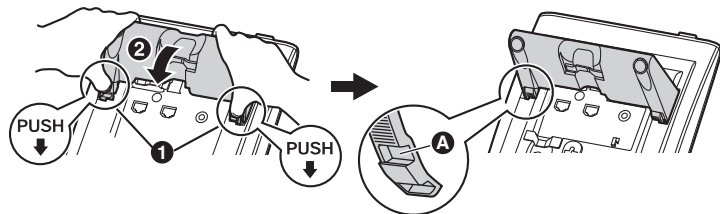

1. Remove the stand if it is attached. For information on removing the stand, refer to page 11.

2. Attach the wall mounting adaptor as shown.

- Make sure the cables are not pinched by the wall mounting adaptor. When running the cables from the top of the unit, look through the opening in the wall mounting adaptor to confirm that the cables are not being pinched.
- Slide the wall mounting adaptor in the direction indicated until it locks into place.

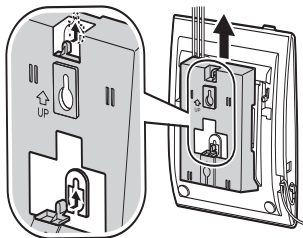

3. Drive the 2 screws into the wall either 83 mm or 100 mm apart, and mount the unit on the wall.

- You can find a wall mounting template on page 19.
- Make sure that the wall that the unit will be attached to is strong enough to support the unit (approx. 1.5 kg).
- Make sure the cables are securely fastened to the wall.
- When this unit is no longer in use, make sure to detach it from the wall.

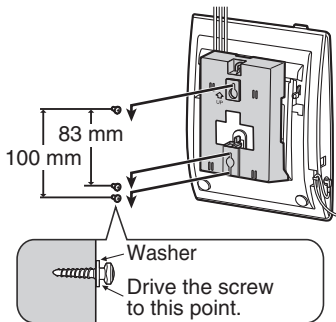

### Locking the Handset Hook

Pull down the handset hook until it locks to prevent the handset from falling off the handset cradle when the unit is mounted to a wall or set at a high angle. To temporarily place the handset down during a conversation, hook it over the top edge of the unit as shown.

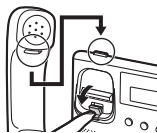

## ***Important Information***

---

**When using a KX-NT321 IP-PT, keep the following conditions in mind.**

- If the unit does not operate properly, disconnect the unit from the Ethernet cable and then connect again.
- If you are having problems making calls, disconnect the Ethernet cable and connect a known working IP-PT. If the known working IP-PT operates properly, have the defective IP-PT repaired by an authorised Panasonic factory service centre. If the known working IP-PT does not operate properly, check the PBX and the Ethernet cable.
- Wipe the unit with a soft cloth. Do not clean the unit with abrasive powders or with chemical agents such as benzene or thinner.
- Use only the correct Panasonic handset.
- Do not disassemble this unit. Dangerous electrical shock could result. The unit must only be disassembled and repaired by qualified service technicians.
- If damage to the unit exposes any internal parts, immediately disconnect the cable or cord. If the power is supplied from the network to the IP-PT [Power-over-Ethernet], disconnect the Ethernet cable. Otherwise, disconnect the AC adaptor cord. Then return this unit to a service centre.
- Never attempt to insert wires, pins, etc. into the vents or other holes of this unit.
- This unit is designed to aid the visually handicapped to locate dial keys and buttons.
- This unit is designed to be installed under controlled conditions of ambient temperature and a relative humidity.
- Avoid installing the unit in damp or humid environments, such as bathrooms or swimming pools.
- 999 and 112 can be dialled on the product after accessing the outside line for the purpose of making outgoing calls to the BT emergency (999) and (112) services (United Kingdom only).

**Take special care to follow the safety suggestions listed below.**

### **Safety**

- 1) The unit should only be connected to a power supply of the type described in the Quick Reference Guide or as shown on the label on the unit.
- 2) When left unused for a long period of time, the optional AC adaptor should be unplugged from the AC outlet, if you are using Power-over-Ethernet, disconnect the Ethernet cable.

### **Installation**

#### **Environment**

- 1) Do not use this unit near water, for example, near a bathtub, washbowl or sink. Damp basements should also be avoided.
- 2) Keep the unit away from heating appliances and devices that generate electrical noise, such as fluorescent lamps, motors and televisions. These noise sources can interfere with the performance of the unit. It also should not be placed in rooms where the temperature is less than 5 °C or greater than 40 °C.

#### **Placement**

- 1) Do not place heavy objects on top of this unit.
- 2) Care should be taken so that objects do not fall onto, and liquids are not spilled into, the unit. Do not subject this unit to excessive smoke, dust, moisture, mechanical vibration, shock or direct sunlight.
- 3) Place the unit on a flat surface.

### **WARNING:**

TO PREVENT POSSIBLE FIRE OR ELECTRIC SHOCK, DO NOT EXPOSE THIS UNIT TO RAIN OR MOISTURE.

THIS HANDSET EARPIECE IS MAGNETISED AND MAY RETAIN SMALL FERROUS OBJECTS.

DISCONNECT THIS UNIT FROM POWER OUTLET/THE ETHERNET CABLE IF IT EMITS SMOKE, AN ABNORMAL SMELL OR MAKES UNUSUAL NOISE. THESE CONDITIONS CAN CAUSE FIRE OR ELECTRIC SHOCK. CONFIRM THAT SMOKE HAS STOPPED AND CONTACT AN AUTHORISED SERVICE CENTRE.

## ***Important Information***

---

### **IMPORTANT NOTICE:**

- Under power failure conditions, the IP-PT may not operate. Please ensure that a separate telephone, not dependent on local power, is available for use in remote sites in case of emergency.
- For information regarding network setup of the IP-PT such as IP addresses, please refer to the Installation Manual for the Panasonic PBX.
- If an error message is shown on your display, consult your dealer or the network administrator.
- The firmware of the KX-NT321 is protected by copyright laws and international treaty provisions, and all other applicable laws. It cannot be reverse engineered, decompiled or disassembled.

This unit is capable of being used in conjunction with hearing aids fitted with inductive coil pick-ups. The handset should be held as for normal conversation. For operation, the hearing aid should be set to its "T" position or as directed in the operating instructions for the hearing aid.



### **Information on Disposal for Users of Waste Electrical & Electronic Equipment (private households)**



This symbol on the products and/or accompanying documents means that used electrical and electronic products should not be mixed with general household waste.

For proper treatment, recovery and recycling, please take these products to designated collection points, where they will be accepted on a free of charge basis. Alternatively, in some countries you may be able to return your products to your local retailer upon the purchase of an equivalent new product.

Disposing of this product correctly will help to save valuable resources and prevent any potential negative effects on human health and the environment which could otherwise arise from inappropriate waste handling. Please contact your local authority for further details of your nearest designated collection point.

Penalties may be applicable for incorrect disposal of this waste, in accordance with national legislation.

### **For business users in the European Union**

If you wish to discard electrical and electronic equipment, please contact your dealer or supplier for further information.

### **Information on Disposal in other Countries outside the European Union**

This symbol is only valid in the European Union.

If you wish to discard this product, please contact your local authorities or dealer and ask for the correct method of disposal.

## ***Important Information***

---



This product is intended to be connected to a Panasonic PBX only. Panasonic Communications Company (U.K.) Ltd. declares that this equipment is in compliance with the essential requirements and other relevant provisions of Radio & Telecommunications Terminal Equipment (R&TTE) Directive 1999/5/EC.

Declarations of Conformity for the relevant Panasonic products described in this manual are available for download by visiting:

**<http://www.doc.panasonic.de>**

Contact to Authorised Representative:

Panasonic Testing Centre

Panasonic Marketing Europe GmbH

Winsbergring 15, 22525 Hamburg, Germany

## WALL MOUNTING TEMPLATE

1. Drive the screws into the wall as indicated.
2. Hook the unit onto the screw heads.

### **Note:**

Make sure to set the print size to correspond with the size of this page. If the dimensions of the paper output still deviate slightly from the measurements indicated here, use the measurements indicated here.

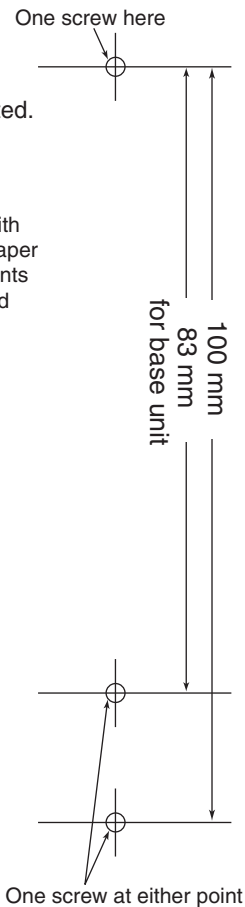

**Panasonic Business Systems U.K.**

Panasonic House, Willoughby Road, Bracknell,  
Berkshire RG12 8FP

**Copyright:**

This material is copyrighted by Panasonic Communications Co., Ltd., and may be reproduced for internal use only. All other reproduction, in whole or in part, is prohibited without the written consent of Panasonic Communications Co., Ltd.

© 2008 Panasonic Communications Co., Ltd. All Rights Reserved.

**PSQX4660YA-GQ** KK0208YH1028 (UK)